

# UTENSILI SVASATORI – SENKWERKZEUGE COUNTERSINK TOOLS – OUTILS POUR CHANFREINAGE



DSUT.599

## KIT KCS

- ✓ prezzo ridotto!
- ✓ dotazione: 1 utensile + 6 inserti in metallo duro TiN per acciai + 3 viti + 1 cacciavite bandiera

## KIT KCS



- ✓ Reduzierter Preis!
- ✓ inkl: 1 werkzeug + 6 ST wendepplatten + 3 Torx schrauben + 1 Torx schraubendreher

## KIT KCS

- ✓ low cost!
- ✓ supply: 1 tool + 6 carbide inserts TiN coated for steel + 3 screws + 1 wrench

## KIT KCS

- ✓ prix réduit!
- ✓ livraison: 1 outil + 6 plaquettes carbure TiN pour acier + 3 vis + 1 tournevis à drapeau

CODICE CODE	TIPO MODEL	CAPACITA' RANGE	α°	GAMBO UTENSILE TOOL SHANK	REFRIGERAZIONE COOLANT SUPPLY	LISTINO PRICE LIST
DSUT.599.12.01	KCS12-2890	4 – 28 mm	90°	12	EXT	€ 260,00
DSUT.599.12.01F	KCS12-2890-F	4 – 28 mm	90°	12F	INT 	€ 290,00
DSUT.599.16.02F	KCS16-2890-F	4 – 28 mm	90°	16F	INT 	€ 308,00
DSUT.599.16.01	KCS16-4090	16 – 40 mm	90°	16	EXT	€ 300,00
DSUT.599.12.03	KCS12-2860	11 – 28 mm	60°	12	EXT	€ 270,00

## UTENSILI PERFETTI LAVORAZIONI SENZA VIBRAZIONI

- ✓ UTENSILI A FISSAGGIO MECCANICO CON 3 TAGLIENTI
- ✓ SVASATURE, SMUSSI E FRESATURE PERIFERICHE
- ✓ INSERTI IN METALLO DURO RIVESTITI O NUDI CON SPOGLIA LOGARITMICA
- ✓ PERFETTO POSIZIONAMENTO = PRECISIONE = RIPETIBILITA'
- ✓ 1 SOLO TIPO DI INSERTO PER DIVERSE LAVORAZIONI

## PERFECT TOOLS MACHININGS WITHOUT VIBRATIONS

- ✓ COUNTERSINK TOOLS WITH 3 CUTTING EDGES
- ✓ SUITABLE FOR COUNTERSINK, CHAMFER AND PERIPHERAL MILLING OPERATIONS
- ✓ COATED OR UNCOATED SPECIAL CARBIDE INSERTS WITH LOGARITHMIC BLADES
- ✓ PERFECT POSITIONING = HIGHEST PRECISION AND REPEATABILITY
- ✓ THE SAME INSERTS ARE SUITABLE FOR DIFFERENT APPLICATIONS

## IDEALE WERKZEUGE BEARBEITUNGEN OHNE VIBRATIONEN

- ✓ WERKZEUG MIT MECHANISCHER FIXIERUNG MIT 3 WENDEPLATTEN
- ✓ IDEAL FÜR DURCHFÜHRUNG VON SENKUNGEN, ABSCHRÄGUNGEN UND PHASEN
- ✓ EINSÄTZE IN HARTMETALL MIT LOGARITHMISCHER SCHNEIDKANTE
- ✓ PERFEKTE POSITIONIERUNG = PRÄZISION = WIEDERHOLBARKEIT
- ✓ 1 EINZIGE WENDEPLATTEN TYPOLOGIE FÜR VERSCHIEDENE BEARBEITUNGEN





## OUTILS PARFAITS TRAVAUX PRECIS SANS VIBRATIONS

- ✓ OUTILS COUPANT A' TROIS COUTEAUX INTERCHANGEABLE RECTIFIES
- ✓ GAMME COMPLETE DE CHANFREIN AVEC UN SEUL OUTIL
- ✓ INSERTS EN CARBURE AVEC/SANS REVÊTEMENT
- ✓ LAMES AVEC PROFIL LOGARITHMIQUE
- ✓ POSITIONNEMENT PARFAIT = PRECISION = REPETABILITE
- ✓ 1 SEUL TYPE D'INSERT POUR DIFFÉRENTS TRAVAUX

### VELOCITA' DI TAGLIO m/min - CUTTING DATAS m/min

Avanzamento fz suggerito : 0,03 mm x tagliente x giro = approx. 0,1 mm per giro  
Suggested feed fz : 0,03 x insert x rev. = 0,1 mm/rev.

	P ACCIAIO	M INOX	K GHISA	N NON FERROSI	S LEGHE TITANIO	H TEMPRATO
MD+TiN	80 – 150	40 – 80	100 – 200	-	20 – 45	10 – 40
MD	-	-	60 – 100	150 – 300	15 – 40	-

 LAVORAZIONI SU MATERIALI DURI => UTILIZZARE SEMPRE UTENSILE CON GAMBO D16 mm  
 HARTSTAHLBEARBEITUNG => DAS WERKZEUG MIT SCHAFTDURCHMESSER 16 mm WIRD DRINGEND EMPFOHLEN  
 HARD STEEL MACHINING => THE TOOL WITH SHANK DIAM. 16 mm IS HIGHLY SUGGESTED  
 USINAGE DE L'ACIER DUR => L'OUTIL AVEC DIAMÈTRE DE MANCHE 16 mm EST HAUTEMENT SUGGÉRÉ

**DIESS** TOOLING

commerciale@dscat.at

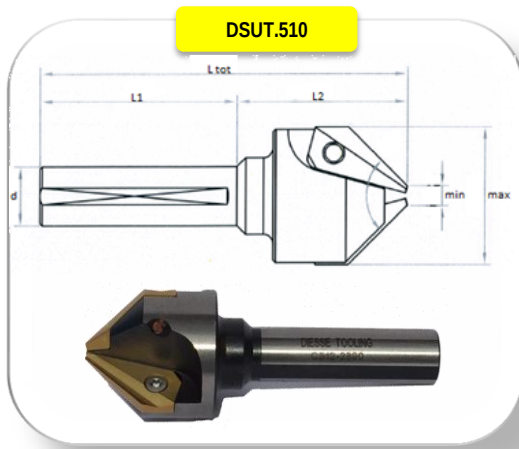

## UTENSILI CS

- ✓ utensili con 3 sedi per inserti in metallo duro (gli inserti sono da ordinare separatamente)
- ✓ svasature, smussi e fresatura periferica con 1 solo utensile!

## COUNTERSINK CS

- ✓ tools with 3 seats for carbide inserts (to be ordered separately)
- ✓ suitable for countersink, chamfer and peripheral milling machinings

## SENKWERKZEUGE CS

- ✓ werkzeuge mit mechanischer fixierung mit 3 wendepplatten ideal für durchführung von senkungen, abschrägungen und phasen (die Einsätze müssen separat bestellt werden)

## OUTILS CS

- ✓ outils avec 3 sieges pour plaquettes (les plaquettes doivent être commandés séparément)
- ✓ évasement, chanfreinage et fraisage périphérique avec un seul outil

CODICE CODE	TIPO MODEL	CAPACITA' min - max	$\alpha^\circ$	d	L TOTALE	L1	L2	REFRIG. COOLANT	LISTINO PRICE LIST
DSUT.510.12.2890	CS12-2890	4,2 – 28 mm	90°	12	74,8	40	34,8	EXT	€ 130,00
DSUT.510.12.2890F	CS12-2890-F	4,2 – 28 mm	90°	12F	74,8	40	34,8	INT	€ 160,00
DSUT.510.16.2890F	CS16-2890-F	4,2 – 28 mm	90°	16F	107	72,2	34,8	INT	€ 180,00
DSUT.510.16.4090	CS16-4090	16 – 40 mm	90°	16	107	72,2	34,8	EXT	€ 170,00
DSUT.510.12.2860	CS12-2860	11 – 28 mm	60°	12	77,5	40	37,5	EXT	€ 140,00
DSUT.VRX.08		Viti ricambio (confezione 30 viti) Torx screws (30 pcs.)							
DSUT.CRX.08		Cacciavite a bandiera Torx wrench							



## INSERTI TIPO CS

- ✓ inserti in metallo duro (rivestiti/non)
- ✓ profilatura con macchina 5 assi
- ✓ spoglia logaritmica = profilo costante
- ✓ fornitura: ogni SET comprende 3 inserti

## CARBIDE BLADES CS

- ✓ carbide blades (coated/uncoated) with logarithmic cutting edge
- ✓ special manufacturing with 5 axis machine
- ✓ supply: each SET consists of 3 carbide blades

## WENDEPLATTEN CS

- ✓ einsätze in hartmetall mit logarithmischer schneidkante (beschichtet/unbeschichtet); bearbeitung erfolgt auf 5-achsmaschinen
- ✓ lieferumfang: jedes set besteht aus 3 wendepplatten

## PLAQUETTES CS

- ✓ plaquettes en carbure; bordure de coupe logarithmique = profil constant
- ✓ le travail des plaquettes est fait sur des machines à 5 axes
- ✓ livraison: chaque jeu comprend 3 plaquettes

CODICE CODE	TIPO MODEL	RIVESTIMENTO COATING	UTILIZZO CONSIGLIATO SUGGESTED USE	LISTINO PRICE LIST
DSUT.519.2890	ST	SI / YES	Acciai fino a 80 kg/mm <sup>2</sup> + Inox Steel up to 80 kg/mm <sup>2</sup> + Inox	€ 90,00
DSUT.519.2891	ALU	NO	Alluminio e leghe leggere Aluminium	€ 88,00
DSUT.519.2892	GG	SI / YES	Ghisa grigia Grey cast iron	€ 90,00